

Index

Basic Surgical -----P2-8

Surgical thread-----P2-4

Needle-----P4

Blade &Knife-----P4-5

Scissors-----P6

Forceps-----P7-8

Basic Diagnosis -----P9-23

Stethoscope-----P9-11

Sphygmomanometer-----P11-14

Thermometer-----P15-16

NET endoscope-----P16-18

Examine light-----P19-20

Facial features inspector-----P21-23

Eye sight box-----P23

Tongue depressor-----P23

Infusion -----P24-27

Disposable syringe-----P24

Insulin syringe-----P24

Auto destroy syringe-----P24

Infusion set-----P25

Blood transfusion-----P25

Scalp vein needle-----P25

Infusion pump-----P26-27

Orthopedics-----P27-34

First aid bandage-----P27

Aloe wound protection bandage-----P28

Hydrogel Dressing-----P28

Swab-----P29

Vaseline

gauze-----P30

Gauze ball-----P30

Gauze bandage-----P31

Triangular bandage-----P32

Plaster bandage-----P32

Adhesive bandage/tape/plaster-----P32-34

First Aid -----P35-43

First aid kit-----P35-39

Foldaway stretcher-----P40-41

Oxygen mask-----P42-43

Doctors' protective-----P43-49

Surgical gown-----P43

Surgical drape-----P44

Protective

gown-----P44

Sleeves-----P45

Bed sheet/pillow case-----P45

Apron-----P45

Gloves-----P46-47

Mask-----P47-48

Shoes cover-----P48

Cap-----P48-49

For old people -----P50-64

Oxygen concentrator-----P50-51

Anti-decubitus-----P51-52

Inflatable hair wash basin-----P52

Portable phlegm suction unit-----P52-53

Medicine timer box-----P53-56

Toilet raiser-----P56-57

Hearing aid-----P57-61

Cervical vertebra traction device-----P62

Massager-----P63

Personal care -----P65

Sterile Surgical Atraumatic Thread

TRD01

Absorbable PGA Suture

Component parts: Ethanoic Acid、Lactic Acid

Construction: Stranded Tight Braid

Absorption: By single resolving of water

Specification: USP8/0-2#

Types of Needle Shape: 1/2circle ●○▲ ▽▽ (8mm-60mm)

3/8circle ●○▲ ▽▽ (8mm-60mm)

straight cutting ●○▲ ▽▽ (30mm-90mm)

Sterilization: Sterilized by Ethylene Oxygen.

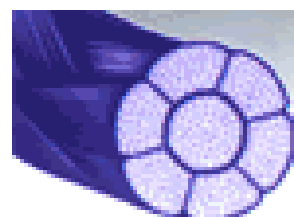

TRD02

Chromic Catgut (Absorbable) Suture

Component parts: Composed by purified animal intesiness(cattle and sheep)

Construction: Monofilament, Smooth Suture Surface

Absorption: Absorb by protease decomposition

Diameters of sutures: USP6/0-3#

Types of Needle Shape: 1/2circle ●○▲ ▽▽ (8mm-60mm)

3/8circle ●○▲ ▽▽ (8mm-60mm)

Straight Cutting ●○▲ ▽▽ (8mm-60mm)

Sterilization: Sterilized by Gamma Radiation

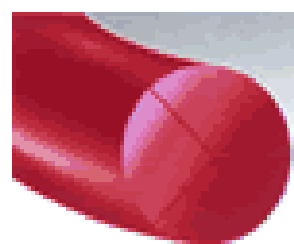

TRD03

Plain Catgut (Absorbable) Suture

Component parts: Composed by purified animal intesiness (cattle and sheep)

Structure: Monofilament, Smooth Suture Surface

Absorption: Absorb by protease decomposition

Diameters of sutures: USP6/0-3#

Types of Needle Shape: 1/2circle ●○▲ ▽▽ (8mm-60mm)

3/8circle ●○▲ ▽▽ (8mm-60mm)

Straight Cutting ●○▲ ▽▽ (30mm-90mm)

Sterilization: Sterilized by Gamma Radiation



TRD04

Silk (Braided) Suture

Component part: Natural Silk

Structure: Braided strands

Absorption: Non-absorbable

Diameters of sutures: USP6/0-2#

Types of Needle Shape: 1/2circle ●○▲ ▽▽ (8mm-60mm)

3/8circle ●○▲ ▽▽ (8mm-60mm)

Straight Cutting ●○▲ ▽▽ (30mm-90mm)

Sterilization: Sterilized by Gamma Radiation

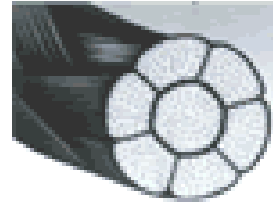

TRD05

Nylon (Non-absorbable) Suture

Component parts: Polypropylene (Nylon)

Structure: Monofilament, Smooth Suture Surface

Absorption: Non-absorbable

Diameters of sutures: USP10/0-2#

Types of Needle Shape: 1/2circle ●○▲ ▽▽ (8mm-60mm)

3/8circle ●○▲ ▽▽ (8mm-60mm)

Straight Cutting ●○▲ ▽▽ (30mm-90mm)

Sterilization: Sterilized by Gamma Radiation

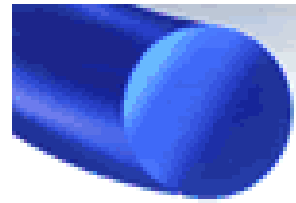

TRD06

Polypropylene Suture

Component part: Polypropylene

Structure: Monofilament, Smooth Suture Surface

Absorption: Non-absorbable

Diameters of sutures: USP10/0-2#

Types of Needle Shape: 1/2circle ●○▲ ▽▽ (8mm-60mm)

3/8circle ●○▲ ▽▽ (8mm-60mm)

Straight Cutting ●○▲ ▽▽ (30mm-90mm)

Sterilization: Sterilized by Gamma Radiation

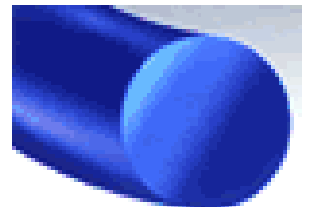

TRD07

Polyester (Braided) Suture

Component part: Polyester

Structure: Strands braided

Absorption: Non-absorbable

Diameters of sutures: USP6/0-2#

Types of Needle Shape: 1/2circle ●○▲ ▽▽ (8mm-60mm)

3/8circle ●○▲ ▽▽ (8mm-60mm)

Straight Cutting ●○▲ ▽▽ (30mm-90mm)

Sterilization: Sterilized by Gamma Radiation

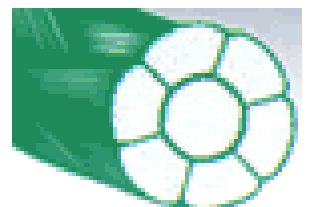

TRD08

Stainless Steel Wire

Component part: Polypropylene

Structure: Monofilament, Smooth Suture Surface

Absorption: Non- absorbable

Diameters of sutures: USP10/0-3#

Types of Needle Shape: 1/2circle ●○▲▽▽ (8mm-60mm)

3/8circle ●○▲▽▽ (8mm-60mm)

Straight Cutting ●○▲▽▽ (30mm-90mm)

Sterilization: Sterilized by Gamma Radiation

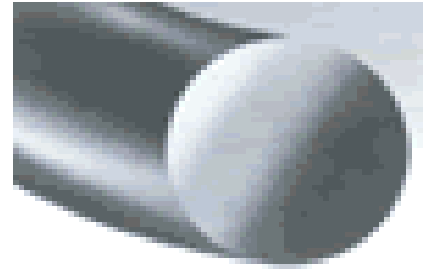

Sterile surgical atraumatic

NDL01

Main Target of Property:

Hardness:490—590HV0.2

Puncture force:≤0.78N

Elasticity: Deformed Drgree≤2%

Effect of Irradiation sterilized effect: Sterilized

12 Pcs/box

50Box/carton

According to customer request



Blade & Knife

BLD01

Disposable carbon steel surgical blades

(Sterilized by Gamma Radiation)

Specs: No. 10, 11, 12, 14, 15, 18, 20, 21, 22, 23, 24, 25,36.



BLD02

Disposable stainless steel surgical blades

(sterilized by Gamma Radiation)

Specs: No. 10, 11, 12, 14, 15, 18, 20, 21, 22, 23, 24, 25,36.

Package:

100pcs/box

50boxes/carton

Design/package can be done according to customer request.



BLD03

Disposable carbon steel surgical blades with plastic handle

(sterilized by Gamma Radiation)

Specs: No. 10, 11, 12, 14, 15, 18, 20, 21, 22, 23, 24, 25



BLD04

Disposable stainless steel surgical blades with plastic handle

(sterilized by Gamma Radiation)

Specs: No. 10, 11, 12, 14, 15, 18, 20, 21, 22, 23, 24, 25.

Package:

Aluminium foil or PVC plastics.

10pcs/box

50boxes/carton

Design/package can be done according to customer request.



BLD05

Stainless Steel Surgical Knife Handle

(Sterilized by Gamma Radiation)

Specs: No. 3, 4

Package: 10pcs/box



BLD06

Disposable Steel Blood Lanlets

(Sterilized by Gamma Radiation)

100pcs/box

50boxes/carton



BLD07

Ophthalmic Knives



Scissors

SSRS01

Scissors, Operating

Material: stainless steel

Specs:

S/S S/B B/B

Sharp/sharp sharp/blunt blunt

Straight Curved

Size: 12.5cm 14cm 16cm 18cm



SSRS02

Scissors, Metzenbaum

Material: stainless steel

Specs: Curved

Size: 16cm 18cm 20cm 22cm 25cm

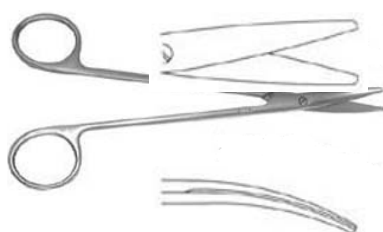

SSRS03

Scissors, Fine

Material: stainless steel

Specs: delicate

Size: 18cm 20cm 22cm 25cm 26cm

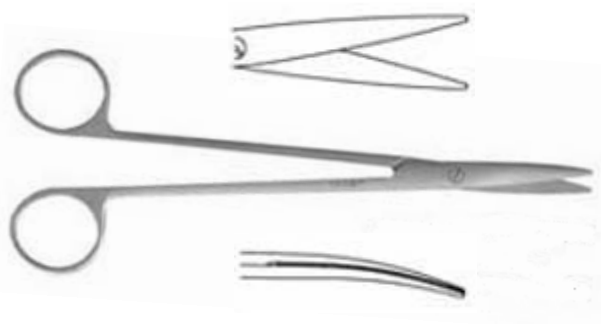

SSRS04

Scissors, Dissect

Material: stainless steel

Size: 15cm 18cm



Forceps

FCP01

Forceps, Hemostatic

Material: stainless steel

Specs:

Straight/Curved

14cm 16cm 18cm 20cm 22cm 24cm

14cm 16cm 18cm

12.5cm 14cm 16cm 18cm 20cm 22cm 24cm

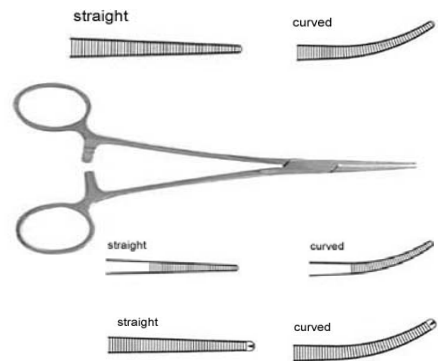

FCP02

Forceps, Sponge Holding

Materials: stainless steel

Specs:

Straight/Curved

25cm 8mm

25cm 10mm

25cm 12mm

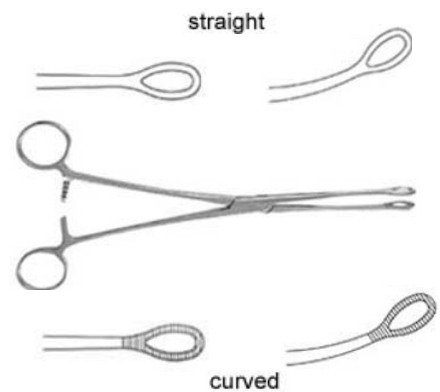

FCP03

Forceps, Towel

Materials: stainless steel

Size: 9cm 10cm 11cm 14cm 16cm



FCP04

Forceps, Allis/Tissue

Materials: stainless steel

Specs

Size: 14cm 16cm 18cm

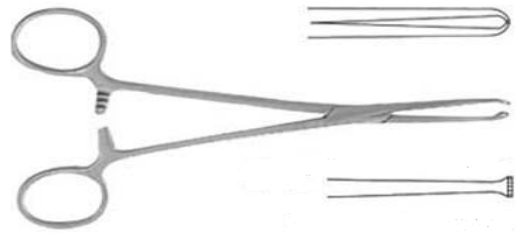

FCP05

Forceps, Dressing

Material: stainless steel

Specs

Size: 12.5cm 14cm 16cm 18cm 20cm 22cm 25cm



FCP06

Forceps, Atraumatic

Material: stainless steel

Specs: as in the pic

Size: 18cm tip 1.8

22cm tip 2.6



FCP07

Forceps, Atraumatic

Material: stainless steel

Size: 16cm tip 1.8/2.4/3.0

18cm tip 1.8/2.4/3.0

20cm tip 1.8/2.4/3.0

22cm tip 1.8/2.4/3.0

25cm tip 1.8/2.4/3.0

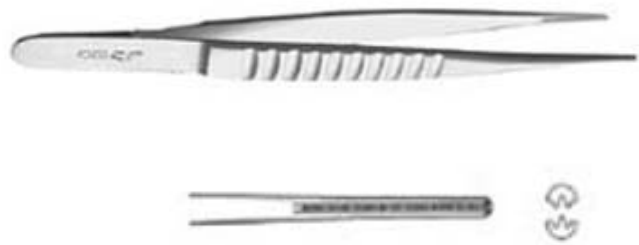

Stethoscope

STTHS01

Single head Stethoscope

A professional stethoscope that monitors heart and respiratory sounds, and also detects fetal sounds. Medium chest piece. Chrome-plated or oxidized chest piece. Flat chest piece has single stem. Hard PVC ear tips. Matched colorful PVC tubing, binaural, chest piece are available.



STTHS02

Dual-head Stethoscope

Lightweight anodized aluminum chestpiece with color coordinated 22" PVC tubing. Chrome-plated brass binaurals adjusts easily for comfort. Chrome-plated external spring with white plastic eartips.



STTHS03

Dual-head Stethoscope

Constructed with an Zinc alloy bell & light weight chest piece to appreciate high/low frequency sounds with super acoustic sensitivity.



STTHS04

Fetal type Dual-head Stethoscope

Designed for superior auscultation of the fetal, Matched colorful PVC tubing and diaphragm rings are available.



STTHS05

Sprague Rappaport type Stethoscope

Chrome-plated binaurals and fully rotatable chestpiece. 22" tubes, Accessory kit includes: 2 Diaphragms, 2 Pairs of ear tips, 3 Bells. Colored chest piece can be matched the colorful latex free tubing. Gel colorful PVC tubes are also available.



STTHS06

Deluxe Single head Stethoscope

Deluxe nickel-plated chest piece, Nickel-plated and internal spring binaural for professional purpose.



STTHS07

Deluxe Dual-head Stethoscope

Features a developed new design chrome-plated zinc alloy chest piece, screw-on retaining ring, and internal spring binaural, matched tubing, and non-chill ring, for professional purpose.



STTHS08

Stainless Steel Cardiology type Stethoscope

Features a stainless steel chest piece for maximum convenience, and internal spring binaural for high acoustic sensitivity. Dual non-chill rings provide patient comfort. Comes complete with additional one diaphragm and a pairs of ear-tips



STTHS09

Stainless Steel type Stethoscope

Premium quality stainless steel chest piece offers superior clear sound transmission. Features in internal spring, stainless steel binaural, non-chill ring, and quality diaphragm.



STHS10

Visual Stethoscope

The core technology of the Visual Stethoscope is from the professors of Tsing Hua University. It breaks the scope of the traditional clinic electrical products, and perfectly shows the design idea of making technology humanity. The product is suitable for use in family, hospital, social medical organizations, physical care in sports. The product has passed the FDA authorization (No. 510(K)-K050097), and got the right of sales in the Northern American and Canada.



Mercury (aneroid) sphygmomanometer

MSGMN01

Desk type Mercurial Sphygmomanometer

A Glass tube(3mm) B-3.2mm C-3.5mm
Standard Cotton Cuff
2-tube Adult size Bladder
standard Latex Bulb
Standard Valves
Latex tube with connector



MSGMN02

Aluminum Plate Mercurial Sphygmomanometer

Glass tube 3mm
Standard Cotton Cuff
2-tube Adult size Bladder
standard Latex Bulb
Standard Valves
Latex tube with connector



MSGMN03

Mercurial Sphygmomanometer in big plastic box

Mercurial Sphygmomanometer
Single stethoscope
Clinical thermometer, oral



MSGMN04

Mercurial Sphygmomanometer in small plastic box

Mercurial Sphygmomanometer

Single stethoscope



MSGMN05

Desk stand type Mercurial Sphygmomanometer

Cuff basket

glass tube 3.2mm

Standard Cotton Cuff

2-tube Adult size Bladder

standard Latex Bulb

Standard Valves

Latex tube with connector

PVC tube 2m



MSGMN06

Wall type Mercurial Sphygmomanometer

A-3.0mm/B-3.2mm/C-3.5mm

Cuff box

Standard Cotton Cuff

2-tube Adult size Bladder

standard Latex Bulb

Standard Valves

Latex tube with connector



MSGMN07

Deluxe Mercurial Sphygmomanometer

big bottle

Glass tube(3.5mm)

Standard Cotton Cuff(52 ~ 14.5cm)

2-tube Adult size Bladder

Standard Latex Bulb

Standard End Valve

Standard Valve

latex tube with connector(25CM)



MSGMN08

Deluxe digital Mercurial Sphygmomanometer

- big bottle
- Glass tube(3.5mm)
- blue nylon cuff with digital stethoscope
- Digital stethoscope
- 2-tube Adult size Bladder
- Standard Latex Bulb
- Automatic deflate Valve
- Standard End Valve



MSGMN09

Stand type Mercury sphygmomanometer

- Glass tube 4.0mm
- 3-wheel with hob
- Metal tube, Adjustable Height 108-150cm
- Standard Cotton Cuff
- 2-tube Adult size Bladder
- standard Latex Bulb
- Standard Valves
- Latex tube with connector



MSGMN10

Aneroid sphygmomanometer

- Standard Cotton Cuff
- 2-tube Adult size Bladder
- standard Latex Bulb
- Standard Valves
- Vinyl zipper bay



MSGMN11

Aneroid sphygmomanometer with stethoscope

- Single stethoscope
- Standard Cotton Cuff with D-ring
- size:54X 14.5cm
- 2-tube Adult size Bladder
- standard Latex Bulb
- Standard Valves
- Vinyl zipper bay

Accessories for mercury

Latex bag

Description	Size
MSGMN12 new born	9x3cm
MSGMN13 infant	19x5cm
MSGMN14 child	20x9cm
MSGMN15 adult	20x12cm
MSGMN16 large adult	30x15cm
MSGMN17 thigh	35x18cm

Material: latex

Color: black

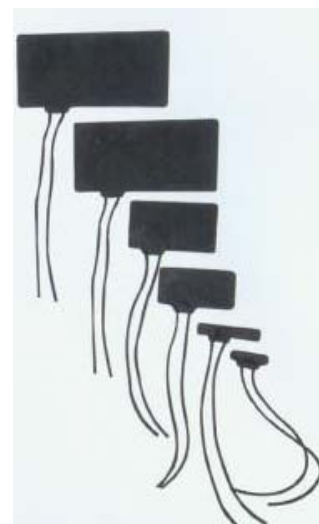

Cuff

	Description	Size
MSGMN18	new born	25x5.5cm
MSGMN19	infant	30x7cm
MSGMN20	child	38x11cm
MSGMN21	standard	52x14.5cm
MSGMN22	adult	56x14.5cm
MSGMN23	adult	54x14.5cm
MSGMN24	adult	52x14.5cm
MSGMN25	thigh	78x22cm



Accessory

	Description	Size
MSGMN26	cuff with metal hook	56x14.5cm
MSGMN27	cuff with metal chip	56x14.5cm
MSGMN28	nylon cuff with D-ring	56x14.5cm
MSGMN29	cotton cuff with D-ring	56x14.5cm
MSGMN30	large adult cuff	66x17.5cm
MSGMN31	lengthen cuff	100x14.5cm

Material: cotton nylon

Thermometer

THMM01

Armpit clinical thermometer (yellow back)

Major and medium trumpet armpit clinical thermometer, outward appearance fine, the reading is clear (separately has yellow back, BaiBei and blue back), 35-42 or 94-108 pair of scale division, length 135mm, a single plastic tube packing 12 block,, 120 center box,, 720 paper box..



THMM02

Oral cavity clinical thermometer

The mercury clinical thermometer, Bai Bei and the yellow back, degree Celsius, mainly uses in the oral cavity. Accuracy: +0.1 -0.1 degree Celsius, length: 11CM, packing: 12/boxes, 720/box, gross weight/net weight: 8/7KGS.



THMM03

Anus clinical thermometer

The mercury clinical thermometer, mainly uses in the anus surveys the human body temperature, 35-42 degree Celsius. Each list plastic packing, 12 dozen, a 720 box.



THMM04

Digital thermometer (general type)

Temperature scope: 32.0-44.0 °C

The LCD arithmetic figure LCD shows

Mouth cavity, armpit, ass 3 usages

Only takes 60 second

Temperature memory



THMM05

Digital Thermometer (flexible tip type)

Temperature scope: 32.0-44.0 °C.

LCD arithmetic figure LCD shows

The Body temperature measurement can adopt the month cavity, armpit, and ass. Three method measurement

Measure time roughly 1 minute, can immediately get the body temperature, digital LCD shows. Voice tells.



It can keep the previous measurement of body temperature.

THMM06

Digital thermometer (baby type)

Just for infant the Digital thermometer of the measurement body temperature design.

This product is a safety, reading easily, fleetness, accurate Digital thermometer.

Temperature scope: 32.0-44.0 °C.

LCD arithmetic figure LCD shows

The body temperature measurement can measures with the mouth cavity method.

Before measuring take a rest first three minutes, to make the mouth cavity inside body temperature stable.



ENT Endoscope

EDS01

Sinoscope

0°

φ2.7mmx175mm

φ3mmx60mm

φ3mmx95mm

φ3mmx175mm

φ3mmx110mm

φ4mmx50mm

φ4mmx90mm

φ4mmx110mm

φ4mmx175mm

φ5.5mmφ20mmx94mm

φ6.5mmφ20mmx78mm

φ8mmφ20mmx200mm

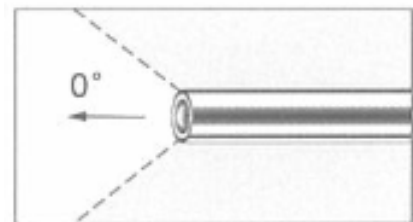

EDS02

Sinoscope

12°

φ3mmx175mm

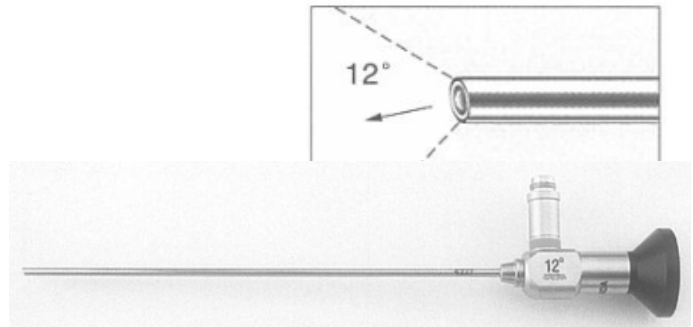

EDS03

Sinoscope

30°

φ2.7mmx175mm

φ3mmx90mm

φ3mmx175mm

φ4mmx90mm

φ4mmx175mm

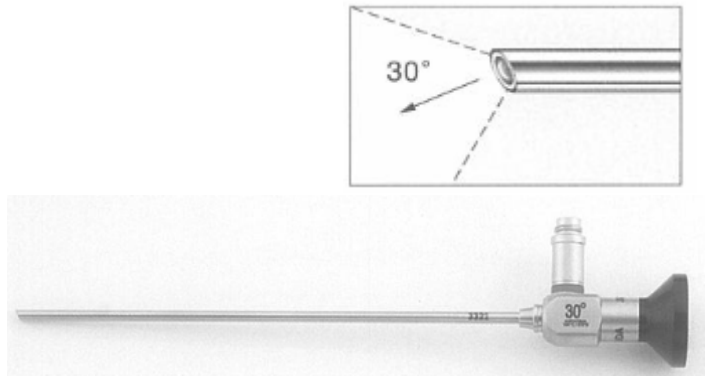

EDS04

45°

φ4mmx175mm

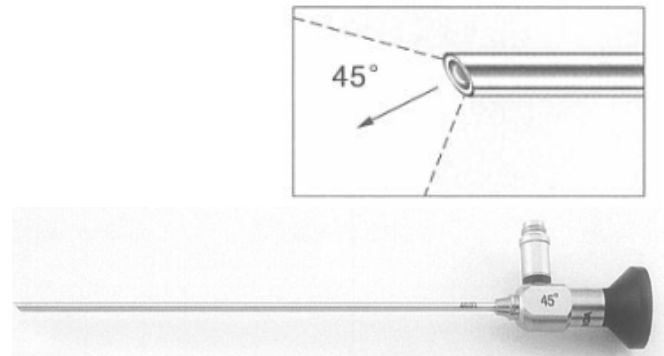

EDS05

70°

φ2.7mmx175mm

φ3mmx175mm

φ4mmx175mm

φ8mmx186mm

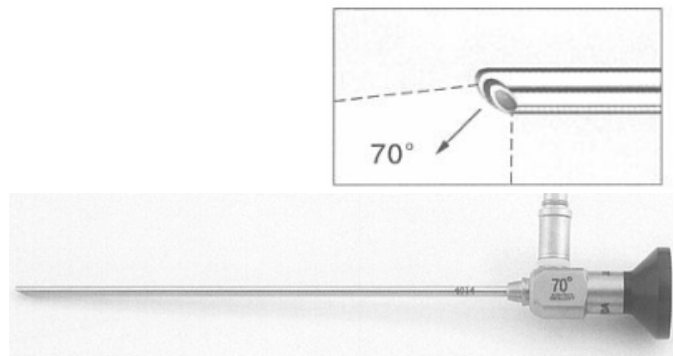

EDS06

Laryngoscope

90°

φ8mmx186mm

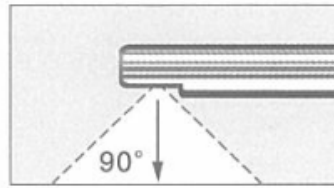

EDS07

Sinoscope

110°

φ4mmx175mm

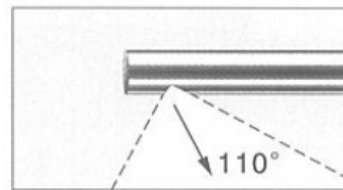

Examine Lamp

EXL01

Big power LCD head lamp

Big power and high brightness

Light spot is clear and adjustable

Universal voltage, apply to AC/DC

Can be connected to magnification and CCD photograph system

Power: 3W

Color Temperature: 6000K

Weight: 400g

Package: 31x21x18cm

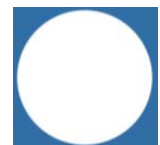

EXL02

LED head lamp

Simple operation
Cost effective
Power: 1W
Color Temperature: 6000K
Weight: 350g
Package: 28x18x15.5cm

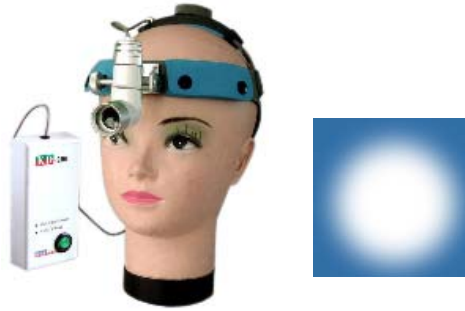

EXL03

Focus and adjustable examination lamp

High Tech
Light spot clear and even
2 light source Choice
: Halogen or LED
Light scope 30cm from the source: 1.8cm to 10cm
Halogen LED
Voltage 30w 3w
Brightness 75000lx 160lm
Length of lamp 127cm 127cm



EXL04

Micro focus examination lamp

Tiny lamp head, light weight
Can apply to AC voltage
Easy to install
High color temperature with low lamp temperature
Can apply to AC /DC voltage, and can last for 4 hrs under DC situation
Power: 3w
Brightness: 160lm
Length of the lamp: 60/130cm



EXL05

Micro focus examination lamp

Tiny lamp head, light weight

(Can apply to AC /DC voltage, and can last for 4 hrs under CD situation)

Easy to install

High color temperature with low lamp temperature

Power: 3w

Brightness: 160lm

Length of the lamp: 60/130cm



EXL06

Ordinary examination lamp

Beautiful design and flexible

High brightness and wide scope of light

Simple and cost effective

Power: 30w

Color: 3000k

Brightness: 120000lx

Length of the lamp: 110cm



Facial Features Inspector

FFI01

Ear/Nose/Throat Diagnostic Set

Ophthalmoscope x1

Otoscope carrier x1

Ear specula (3,4,5,6 mm diam) x4

Nasal apeculum (8mm diam)x1

Dilating nasal speculum x1

Laryngeal mirror stem x1

Laryngeal mirror x3

Tongue depressor plastic x1

Battery handle x1

Spare bulbs (2 large and 4 small) x6



FFI02

Ear/Nose/Throat Diagnosetic Set

- Ophthalmoscope x1
- Otoscope carrier x1
- Ear specula(3,4,5,6 diam)x4
- Nasal apeculum (8mm diam)x1
- Dilating nasal speculum x1
- Laryngeal mirror stem x1
- Laryngeal mirros x3
- Tongue depressor plastic x1
- Battery handle x1
- Spare bulbs(2 large and 4 small) x6
- Transformer x1



FFI03

Direct ophthalmoscope

- Illumination form: big spot, small spot
- Diopter compensation: 0 ±1 ±2 ±3 ±4 ±5 ±6 ±8 ±10 ±12 ±16 ±20-25(D)
- Power supply: 1.5Vx2 C type battery
- Illumination bulb: 2.5V/0.3A



FFI04

Direct ophthalmoscope

- Illumination form: big spot, small spot
- Diopter compensation: 0 ±1 ±2 ±3 ±4 ±5 ±6 ±8±10 ±12 ±16 ±20-25(D)
- Power supply: 1.5Vx2 C type battery or AC 220v
- Illumination bulb: 2.5V/0.3A



FFI05

Otoscope

- Size of the aural: 3,4,5,6,8 mm
- Power supply: 1.5Vx2 C type battery
- Illumination bulb: 2.5V/0.3A



FFI06

Otoscope

- Size of aural: 3,4,5,6,8mm
- Power supply: AC220V, or 1.5Vx2 C type battery
- Illumination bulb: 2.5V/0.3A



FFI07

Eye-examination instrument

Components: ophthalmoscope diopters-examination and flashlight

Power: 1.5VX2 C type battery

Illumination bulb: 2.5V/0.3A

Battery handle: plastic



FFI08

Eye-examination instrument

Components: ophthalmoscope diopters-examination and flashlight

Power: 1.5VX2 C type battery AC220V

Illumination bulb: 2.5V/0.3A

Battery handle: metal



FFI09

Mouth mirror

Size: 21, 23, 27 (diameter, mm)

Model: Flat, concave



FFI10

Laryngeal mirror

Size: 10,12,14,16,18,20,22 (diameter, mm)



FFI11

Skin magnifier

It is used for magnifying(10 times)

Powder supply : 1.5Vx2 AA

Bulb: 2.5V/0.3A



FF12

Eye sight lamp box

Frame: high strength aluminum alloy

Spray coating

Organic glass



Tongue Depressor

TD01

Tongue Depressor

Ways of sterilize: Ethylene Oxide(EO)

Size: 150x18x1.6mm

Package: individual paper bag



TD02

Tongue Depressor

Ways of sterilize: gama irradiation

Size: 150x18x1.6mm

Package: individual plastic/paper bag



Infusion equipment

Disposable syringe (3 parts) 1~50ml

Item No.	Size	Type	General needle size	Service scope
IFS01	1ml	Luer slip Centric nozzle	27G~23G	Ophthalmology, dentistry, etc.
IFS02	2ml	Luer slip Centric nozzle	25G~23G	Intramuscular injection
IFS03	3ml	Luer slip/luer lock Centric nozzle		
IFS04	5ml	Luer slip/luer lock Centric nozzle		
IFS05	10ml	Luer slip/luer lock Centric nozzle	20G or 18G	For dosage during infusion
IFS06	20ml	Luer slip/luer lock Centric nozzle, Luer slip Eccentric nozzle	22G~18G	Intravenous infusion of liquid
IFS07	30ml	Luer slip/luer lock Centric nozzle, Luer slip Eccentric nozzle		
IFS08	50ml	Luer slip/luer lock Centric nozzle, Luer slip Eccentric nozzle		

Disposable syringe (2 parts)

Item No.	Size	Type	General needle size	Service scope
IFS09	2ml	Lure slip Centric nozzle	25G~23G	Intramuscular injection
IFS10	5ml	Lure slip Centric nozzle/Eccentric nozzle	25G~22G	
IFS11	10ml	Lure slip Eccentric nozzle	20G or 18G	For dosage during infusion
IFS12	20ml	Lure slip Eccentric nozzle	22G~18G	Intravenous infusion of liquid

Disposable insulin syringe

Item No.	Size	Type	General needle size	Service scope
IFS13	1ml	Lure slip Centric nozzle	29G,30G	Insulin injection

Disposable Auto destroy syringe

Item No.	Size	Type	General needle size	Service scope
IFS14	3ml	Three-part(F)/Five-part(M), Central type	25G~22G	Intramuscular injection
IFS15	5ml	Three-part(F)/Five-part(M), Central type	23G~22G	Intramuscular injection

Infusion set

Item No.	Type	Description	Service scope
IFS16	IS-V	A connection type of injection moulding drip chamber and plastic spike	With air inlet device, applicable to the infusion vessel needing ventilation(temporary adding medicine from rubber tube).
IFS17	IS-CD	A separation type of blow molding drip chamber and plastic spike.	With air inlet device, applicable to the infusion vessel needing ventilation(temporary adding medicine from rubber tube).

Blood transfusion set

Item No.	Type	Description	Service scope
IFS18	XV	A connection type of injection moulding drip chamber and plastic spike	With air inlet device, applicable to the blood transfusion vessel needing ventilation(temporary adding medicine from rubber tube).

Scalp vein needle

Item No.	Symbol	Needle type(G)	Service scope
IFS19 Scalp Vein Needle (single wing/double wings)	Needle type×Needle cannula length	27~23	Applicable to the intravenous infusion (transfusion) for children.
		22~18	Applicable to the intravenous infusion(transfusion) for adult.



IFS20

Infusion pump

Front

1. Handle
2. Warning lights
3. LCD screen
4. Presetting data keys / Function keys
5. Button panel
6. Auxiliary handle of operation
7. Door handle



Side

8. Auxiliary handle of operation
9. Fixed knob

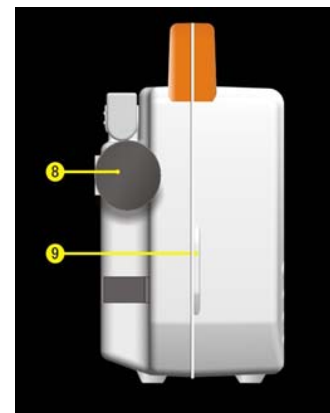

Back

10. Drop detector
11. Alliance of drop detector
12. Drop detector socket
13. Power socket
14. Power Switch
15. Data interface
16. Fixed knob
17. Non-slip rubber mat

Product Characteristics

1. Application of a variety of one-off general infusion devices
2. Ultra-durability and low noise body structure
3. Precise infusion control and automatically correction of precision
4. Two control modes: volume and drop
5. Unique infusion data presetting function
6. Convenience dismounting battery
7. English operating system
8. Reliable whole series of security detection and alarm system
9. High alarm lights
10. The data interface can be connect with network of the nurse station (Alternative)

Alarm and Indicator Function

1. Air and solution emptying
2. Up occlusion
3. Down occlusion
4. Infusion complete
5. Installing error of infusion device

6. Door open
7. Insufficient voltage of battery
8. Infusion operation
9. Purge operation
10. Safety detection and control of circuit fault

Parameters

1. Mechanical principle: Finger- peristaltic
2. Two operation modes: "volume controlled infusion" and "drop controlled infusion" .
3. Uses: Any medical situation needs intravenous infusion or intestine nutrition.
4. Three models' infusion rate range: 1~600 ml/h, 1~1200 ml/h, 1~2500ml/h.
5. Medical Device Product Management Categories: The second category.
6. Equipment type: Portable equipment.
7. Electric Shocks Protection Classification: Class II-B.
8. Coat Protection Grade: IP33
9. Noise: 48dB/350mm
10. Using environment: temperature 5 °C to 40 °C, humidity 35%-85%, atmospheric pressure 860~1060hPa
11. Mechanical stability: it can operate normally even placed horizontally
12. Applicable infusion stand: it can be fixed on diameter of 10mm~28mm of poles.
13. Accuracy : $\pm 2\%$
14. Occlusion detection sensitivity: 0. 03N
15. Net weight: 2 kg.
16. Size: 140 (W) x 120 (D) x 220 (H) mm
17. Power: $\leq 15W$
18. Input voltage: AC220V $\pm 20\%$ / 50Hz or DC12V (can be customized by user's order)
19. Battery: Ni-MH battery 12. 5V, 1800mAh.

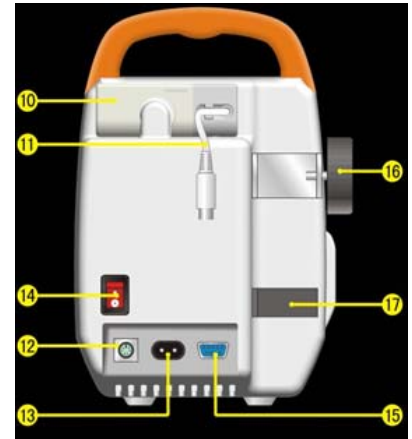

First Aid Bandage

FAB01

First aid bandages

Material: fabric/non woven/PE/PU/PVC

Shape: tube, H shape, butterfly shape, round

Size: according to customer request

Package: one size or mixed/box



FAB02

Aloe wound protection bandage

Contains aloe extract. The active components in Aloe extract have the ability of restoring wound.

Size: according to customer request



Hydrogel Dressing

GELD01

Usage:

Burn cure

Burn wound of I degree, low II degree, and deep II degree with a little trend to low.

Deep II degree burn wound after cutting scar.

Surface ulcer cure

Ulcer, diabetes mellitus foot ulcer, decubital ulcer, and radioactivity skin injury caused by pathological changes of crura vein.

Epidermis injury caused by other trauma

Wound by surgery and orthopedic operation

General (HD-L): 20*12.5cm², 12*8cm² Enlargement (HD-M) : 20*12.5cm², 12*8cm²

[Characteristic Mechanism and Clinical represent]

Characteristic	Mechanism	Clinical represent
Include abundant free water, bound water and combined water	Cool the wound swift	Reduce the severity of the pain, prevent deeper injury
	Create and maintain a dampish condition for concrescence	Accelerate wound cicatrisation; shorten cure cycle; alleviate scar hyperplasia
Special three dimensional network structure	Semi-permeability	Obstruct bacteria; prevent infection; allow oxygen and water to via
	High machine strength,	Easy to operate and observe

	highly clarity	
Good biocompatibility	Adhere firmly yet gently to the healthy surface; not adhere to wet wound surface	painless when exchange for another; avoid mechanical injury for the second time
Advanced manufacturing technique	Gel formation and sterilization are accomplished simultaneously in one step	High purity; no toxic, no stimulate, no sensitization; long storage life, general save condition



Swab

SWB01

Haemostatic gauze

Made of pure cotton fiber which is extracted from plant
Dissolve in water

No structured toxicity. Neither irritating nor allergic to human body

It can break down to low molecular saccharine in human Body

Capacity of water absorption: more than 30 times the weight of its own

Loss on drying: less than 12%

Water insoluble portion: less than 10%

Ph: 7-8



SWB02

Gauze swab

100% cotton

Absorbency $\leq 3s$

Whiteness level $\geq 82\%A$

Renewable and easy to recycle

With/with out X-Ray thread incorporated in to

The sponge

Sterile

Size: 5x5 7.5x7.5 10x10 10x12.5 10x15 10x20 15x20 20x30 (cm)

Plies: 8p, 12p, 16p, 24p, 32p



X-Ray thread

SWB03

Fluff gauze swab

Soft and highly absorbent

Manufactured of pre washed

Fluff dried woven gauze and protection for sensitive wound areas

Size: 6"x6.75" 7.75"x8.75" 9.75"x10.75"

Plies: 12p, 16p



SWB04

Vaseline gauze swab

White/yellow Vaseline

Leno gauze

Size: 10x10cm



SWB05

Non woven swab

70% rayon+30%polyester

Soft and higly absorbent

No lint

Size: 5x5 7.5x7.5 10x10 10x20 15x15(cm)

Plies: 4p, 6p, 8p



SWB06

Cotton swab

Soft and 100% natural

White fiber

Highly absorbent

Size: 3x4 4x4 7.5x7.5 8x8 10x10 10x16 (cm)



SWB07

Zigzag cotton swab

100% cotton

White fibber

Easy to tear

Spec: 10, 25, 50,100,200,250,500 g/poly bag



Gauze ball

GB01

Cotton gauze ball

100% cotton gauze yarn, surgical grade

With or without X-Ray detectable yarn

Shape: round, oval, flat, stripe, hate form, petal

GB02

Non woven ball

70% rayon+30% polyester

Soft, highly absorbent

No lint

With/without elastic ring

30g/m², 40g/m², 50g/m²

Size: Φ 2,2.5,3,3.5,4,4.5,5,5.5,6,6.5, 7 (cm)



Bandages

Gauze bandage

100% cotton

High breath ability

Applicable to infirmary and first aid

Used for the fixing and holding of injured joint or fractured part

Soft and comfortable



B01

W.O.W gauze bandage

Size (cmxm): 5x500, 7.5x500, 10x500, 15x500, 20x500



B02

Gauze bandage with woven edges

Size (cmxm): 2.5x5, 5x5, 7.5x5, 10x5, 15x5, 20x5



B03**Crochet gauze bandage**

Size (cmxm): 2.5x5, 5x5, 7.5x5, 10x5, 15x5, 20x5

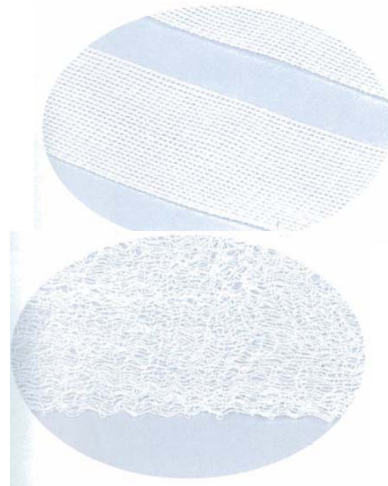
**B04****Shrinking gauze bandage**

Size(cmxm):5x4, 7.5x4, 10x4, 15x4, 11.25x3.5

Plies: 4p, 6p

B05**Triangular bandage**

Soft, comfortable

Convenient for fixing of limbs

100% cotton	Size(cmxcmxcm)
40'Sx40'S	90x90x127
48x48	95x95x135
50x50	90x90x130
68x63	105x105x150
Non-woven	
20g/m2	90x90x127
30g/m2	95x95x136
45g/m2	

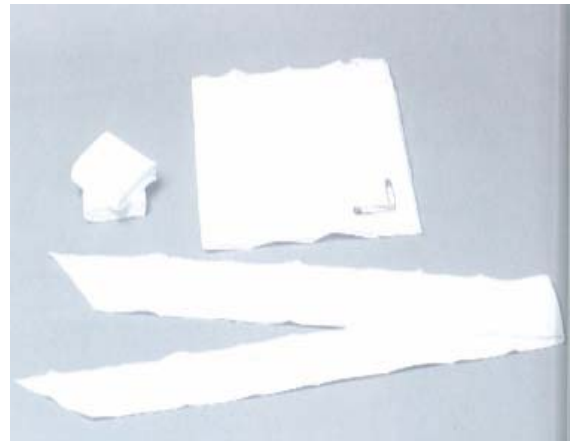
**B06****Plaster bandage**

Most effective, safe and widely used products

In orthopaedics

Few paste powder running off when soaked in water

Solidification time can be controlled within 2-8min

Size(cmxm): 5x2.7, 5x3, 5x4.6, 7.5x2.7, 7.5x3

**B07****Cotton adhesive elastic bandage**

Can be used for strains and sprains

Used for hot/cold packs

Promote circulation and healing

Control swelling and stop bleeding

Can be used as veterinary bandage

Usage: for strains and sprains. Fixing bandage for hot/cold packs. Control swelling and stop bleeding.

Size(cmxc): 2.5x450, 5x450, 7.5x450, 10x450

Color: white with/without yellow middle line

Flesh with/without red middle line



B08

Poly-cotton cohesive flexible bandage

A: 70% cotton, 30% polyamide

Can stick to itself, no need of pins or clips.

Do not stick to hair, skin, and clothes

Soft and breathable

Light pressure, will not avoid blood circulation

Size(cmxm): 4x20, 6x20, 8x20, 10x20, 12x20, 4x4, 6x4, 8x4,10x4, 12x4

Color: white



B09

Poly-cotton cohesive flexible bandage

B: 40% cotton, 60% polyamide

Can stick to itself, no need of pins or clips.

Do not stick to hair, skin, and clothes

Soft and breathable

Light pressure, will not avoid blood circulation

Usage:

Size(cmxm): 4x20, 6x20, 8x20, 10x20, 12x20, 4x4, 6x4, 8x4,10x4, 12x4

Color: white



B10

Non-woven cohesive flexible bandage

Elastic non-woven substrate/ elastic non-woven substrate with latex free

Self stick. No stick to hair, clothes, skin.

Breathable

Hand tear. No need of scissors

Competitive price

Usage: usage for strains and sprains. Fixing bandage for splints, monitors and IVs. First aid bandages. Can be used for animal wrapping.

Size(cmxc): 2.5x450, 5x450, 7.5x450, 10x450, 15x450

Color: white/tan/red/blue/green/yellow



B11

Cotton cohesive flexible bandage

Elastic cotton substrate/ Elastic cotton substrate with latex free

Self stick. No stick to hair, clothes, skin.

Breathable

Hand tear. No need of scissors

Usage: usage for strains and sprains. Fixing bandage for splints, monitors and IVs. First aid bandages.

Size(cmxcn): 2.5x450, 5x450, 7.5x450, 10x450, 15x450

Color: white/Tan/black



B12

Cotton athletic tape

Cotton substrate/cotton substrate with latex free

Non elastic.

Plain/zigzag edge. Easy to tear lengthwise and widthwise

Leaves no residue on body parts

Usage: for strains and sprains. Fixing bandage for hot/cold packs.

Control swelling and stop bleeding. Sports equipment binding.

Size(cmxcn): 2.5x1370, 3.8x1370, 5x1370

Color: bleached white



Adhesive Tape

B13

Water proof

Strong adhesions

For support and protection against injuries

Easy to tear

High breath ability.

No damage skin

Material: Cotton/Non-woven/PE/Paper

Size(cmxcn): 1.25x1, 1.25x5, 1.25x10, 2.5x1,

2.5x5, 2.5x10, 5x5, 7.5x5, 7.5x10, 10x5, 10x10



Adhesive Plaster

B14

Soft, can stretch freely
Good breath ability and conformability
No damage to skin
Specs: zinc oxide adhesive plaster/
drilling adhesive plaster with medicine
Size: 1.25x1, 1.25x5, 1.25x10, 2.5x1, 2.5x5, 2.5x10,
5x5, 5x10, 7.5x5, 7.5x10, 10x5, 10x10

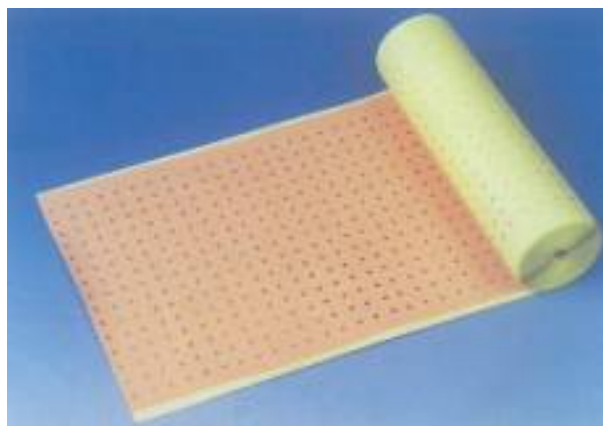

First aid kits

FAK01

SIZE: 320×240mm

Medical product list:

S001 Wound compress(non-woven), size 10cm×10cm, sterilized, cover wound 5

S002 Combine A.B.D pad, 20cm×20cm, used to stypsis 10

N003 Non-woven tape, size 2.5cm×400cm,put in self-sealed pocket plastic pocket with label 1

S004 Elastic bandage(with polymers), size 8cm×450cm, put in PE pocket with label, sealed and sterilized ,cover wound bandage in place. 1



S005 Elastic bandage , size 8cm×400cm, put in PE pocket with label, sealed and sterilized ,cover wound bandage in place. 1

N006 Scissors, size 14.5cm, stainless steel material, put in PE pocket with label, sealed and sterilized tear-off clothing 1

N007 emergency blanket ,packed in self-sealed bag with 1 label, unfolded size 210cm×160cm, folded size 13cm×8.5cm 1

S008 Gauze pad, size 4cm×4cm, put in one side paper and one side plastic packet, sterilized, cover small wounds 5

S009 Gauze pad, size 8cm× 8cm, put in one side paper and one side plastic packet, sterilized, cover small wounds 1

N010 Iodine prep pad, size6. 5cm×3cm, used to disinfect 2

S011 NaCl humid tissue, cleaning wounds 1

N012 Triangle bandage ,size 96cm×96cm×136cm, folded size 13cm×18cm,packet in pillow shape with 1 label immobilize and keep splints in place 1

N013 Single use gloves, large size ,every 2 units packed in self-sealed plastic pocket, protect against

- infections 2
- N014 Safety pins, 3cm, put in self-sealed pocket with 1 label, keep bandage in place 6
- S015 Adhesive bandage, size 7.2cm×1.9cm, cover small wounds 8
- N016 Tweezer (plastic material), size 12cm, put in self-sealed pocket with 1 label, avoid cross infection 1
- S017 Mouth to mouth mask, 20cm×20cm, used for artificial respiration 1
- S018 Alcohol pieces. Size 6.5cm×3cm, used to disinfect 4
- S019 Absorb the blood mat, size 10×10cm, cover wounds 3
- N020 Cold pack, 200g, used to burn 1
- S021 Elastic bandage , size 6cm×400cm, put in PE pocket with label, sealed and sterilized ,cover wound bandage in place 1
- S022 Gauze bandage, size 8cm×600cm, packed in pillow shape with glassine, sterilized, fixed wound dressing 1
- N023 Multi-purpose bandage, size 5cm×450cm, put in PE pocket with label ,cover wound compress in place. 1
- N024 First Aid Guide 1
- N025 Outer bag, store products using for first aid kit. 1
- N means not sterilized, S means sterilized.

FAK02

Medical product list:

- | | | | |
|-------------------------------|--------------------|----|--------|
| Blood-stopper bandage | | 1 | piece |
| Yunnan baiyao powder | | 1 | bottle |
| PVC gloves | | 2 | pair |
| Adhesive bandage | 72 mm×19mm | 20 | piece |
| Iodine cotton bar | 7cm | 30 | piece |
| Iodine cotton ball | 5pcs/bag | 10 | bag |
| Adhesive wound dressing | 6×7cm | 10 | piece |
| Adhesive wound dressing | 8×9cm | 5 | piece |
| Adhesive wound dressing | 10×10cm | 5 | piece |
| Dressing pad | 7.5×7.5cm | 10 | piece |
| Dressing pad | 10×10cm (2pcs/bag) | 2 | bag |
| Fingertip fracture splint | 7×11cm | 1 | piece |
| Electronic thermometer | | 1 | piece |
| Medical tweezers | plastic | 1 | piece |
| Safety pin | metal | 1 | piece |
| First aid blanket sliver | | 2 | piece |
| Compress for burns | 40×60cm | 1 | bag |
| Compress for burns | 60×80cm | 1 | bag |
| Alcohol cotton ball | 30pcs/ball | 1 | ball |
| Triangular bandage | 90 x 90×129 cm | 2 | piece |
| Safety pin | | 4 | piece |
| Self-adhesive elastic bandage | 10cm×2.5m | 2 | roll |
| Self-adhesive elastic bandage | 5cm×2.5m | 8 | roll |
| Fracture splint in roll shape | | 1 | roll |
| Burn plaster | | 1 | bottle |
| Traveling first aid bag | 12×7×5 cm | 1 | piece |
| Glisten vest | | 1 | piece |



Cooling gel sheet single package 2 piece
 Tongue spatula 4 piece
 Breath freshener spray 1 bottle
 Huoluo oil 5ml 1 bottle
 First aid instruction 1 page
 First aid bag 22×32×10 cm 1 piece

FAK03

Size: 460x180mm, Folded size: 180x115x60mm

Medical product list:

S001 Wound compress, size 60cm×40cm, put in one side paper and one side plastic packet, sterilized, cover small wounds 1

S002 NaCl humid tissue, cleaning wounds 2

S003 Disinfect gauze pad ,size 8cm×8cm, every 1 units packed in 2 sides paper pocket, sterilized, cover wounds 4

N004 Adhesive plastic, size 1.25cm×500cm, put in self-sealed plastic pocket with 1 label, keep bandage in place 1

S005 Adhesive dressing, size 10cm×6cm, packed in a self-sealed plastic pocket with 1 label, cover small wounds 8

S006 Single use gloves, large size, every 4 units packed in self-sealed plastic pocket, protect against infections 4

N007 Non-woven triangle cloth, size 96cm×96cm×136cm, folded size 13cm×18cm,packed in pillow shape with label immobilize and keep splints in place 1

N008 High-carbon scissor, size 15cm, high-carbon material, put in PE pocket with label, tear off clothing 1

N009 Safety pins, 3cm, put in self-sealed pocket with 1 label, keep bandage in place 4

S010 Disinfect gauze pad ,size 4cm×4cm, every 1 units packed in 2 sides paper pocket , sterilized, cover wounds 4

S011 Gauze bandage, size 5cm×500cm, packed in pillow shape with glassine, sterilized, fixed wound dressing 2

S012 Adhesive bandage, size 7.2cm×1.9cm, cover small wounds 8

N013 Emergency blanket, packed in self-sealed bag with 1 label, unfolded size 210cm×160cm, folded size 13cm×8.5cm protect against heat and coldness 1

S014 Gauze bandage, size 8cm×400cm, packed in pillow shape with glassine, sterilized, fixed wound dressing 3

N015 Alcohol prep pad. Size 6.5cm×3cm, used to disinfect 4

N016 First aid guide 1

N017 Zipper pocket ,store product using for first aid 1

N means not sterilized, S means sterilized



FAK04

Medical product lists:

N001 Clinical thermometer, for measuring temperature. Piece 1

N002 Scissor, for cutting medical gauze. Piece 1

S003 Wound protection paste, for protecting the wound and diminishing inflammation & haemostasis. Piece 10

S004 75% alcohol cotton ball or alcohol prep pad, for the disinfection and cleaning of skin and commodity. Bag 2



- S005 Iodine prep bar, for the disinfection of normal wounds, flaycuts, brush-burns and scalds, and also for cutaneous infection. Bag 2
- S006 Medical cotton carriers, for cleaning the wounds. Bag 4
- N007 Rubberized fabric, for fixing the dressing. Roll 1
- S008 Medical gauze pad, for protecting or cleaning the wounds. Piece 5
- S009 Medical bandage, for dressing the wounds. Roll 1
- N means not sterilized, S means sterilized

FAK05

Medical product list:

- Adhesive bandage 72×19mm 12 piece
- Iodine cotton bar 7cm24 piece
- Wound dressing pad 6×7cm 5 piece
- Wound dressing pad 8×9cm 5 piece
- Wound dressing pad 10×10cm 5 piece
- Dressing pad 5×5cm 5 piece
- Dressing pad 7.5×7.5cm 5 piece
- Dressing pad 10×10cm (2pcs/bag.) 2 bag
- Scissors metal 1 piece
- Tweezers plastic 1 piece
- Iodine cotton ball 5pcs / bag 1 bag
- Alcohol cotton prep pad5cm×5cm 4 piece
- First aid blanket 208×132 cm 1 piece
- Triangle bandage 90×90×129 cm 1 piece
- PBT elastic bandage 10×450cm 1 roll
- PBT elastic bandage 5×450cm 1 roll
- Adhesive tape 1cm×10m 1 roll
- Safety pins 4 piece
- Month-to-mouth mask 1 piece
- Instant ice bag100g 1 bag
- Thermometer 1 piece
- First aid booklet 1 book
- First aid instruction 1 page
- First aid bag 21×14.5×6.5cm 1 piece



Adhesive bandage: Used to bind the small wound.

Iodine cotton bar: Used to disinfect the small wound. Single package.

Wound dressing: To cover small wounds.

Dressing pad: To stop the blood. It can use to fix on the wound with the self adhesive bandage.

Scissors: Used to cut down the bandage or entangled clothes.

Tweezers: Used to clip iodine cotton ball or some attached variant dressings on the wound.

Iodine cotton ball: It can kill large area of the bacteria, also can use for sterilizing, cleaning.

Alcohol cotton prep pad: Used to disinfect the wound or thermometer .or used to disinfect the hand.

First aid blanket: To cover against coldness and heat.

Triangular bandage: Used to fixing the fracture splint .for example .you can hung the triangular bandage in your neck when you meet the fracture.

PBT elastic bandage: Used to stopping the blood or fastness, bind the wound after the wound was

covered by the wound dressing or dressing pad.

Adhesive tape: Used to fixing the dressing (wound dressing, dressing pad) material.

Safety pin: Used to fix the triangular bandage.

Mouth -to-mouth mask: Used for the mouth-to-mouth artificial respiration, in the case of bacteria infection during the respiration.

Instant ice bag: To activate, squeeze pack until inner pouch bursts. Shake pack well to mix contents after activation. Apply cold pack to desired area. Dispose of cold pack in proper receptacle.

Thermometer: used to measure the body temperature

FAK06

Medical product list:

Scissors 1 Piece
Tweezers 1 Piece
Wound dressing pad 1 Piece
Wound dressing pad 1 Piece
Dressing pad2 Piece
Dressing pad2 Piece
Iodine cotton bar 15 Piece
Alcohol cotton prep pad 10 Piece
Month-to-mouth mask 1 Piece
First aid blanket 1 Piece
Cool gel sheet 2 Piece
Gauze bandage 1 Piece
Triangle bandage 1 Piece
PBT elastic bandage 1 Roll
PVC gloves 1 Pair
Iodine cotton ball 5 Piece
Cleaning humid tissue 1 Piece
Sterilizing humid tissue 1 Piece
Adhesive bandage 4 Piece
Adhesive bandage 4 Piece
Adhesive bandage 10 Piece
Eye pad 1 Piece



Foldaway Stretcher

FAFS01

unfolded size(LxWxH): 185x52x20cm

folded size(LxWxH): 94x52x9cm

net weight: 6kg

Bearing: 159kg

Material:aluminum alloy, oxford cloth

Packing: 2pcs/carton

Carton size: 96x53x18cm

Gross weight: 13kg



FAFS02

unfolded size(LxWxH): 185x52x24cm

folded size(LxWxH): 94x52x12cm

net weight: 8kg

Bearing: 159kg

Material:aluminum alloy, oxford cloth

Packing: 2pcs/carton

Carton size: 96x53x28cm

Gross weight: 19kg

**FAFS03**

unfolded size(LxWxH): 185x52x3cm

folded size(LxWxH): 94x52x7cm

net weight: 3.3kg

Bearing: 159kg

Material:aluminum alloy, oxford cloth

Packing: 2pcs/carton

Carton size: 96x53x16cm

Gross weight: 8kg

**FAFS04**

unfolded size(LxWxH): 185x50x3cm

folded size(LxWxH): 94x50x7cm

net weight: 7kg

Bearing: 159kg

Material: aluminum alloy

Packing: 1pcs/carton

Carton size: 96x53x9cm

Gross weight: 8kg

**FAFS05**

unfolded size(LxWxH): 185x50x3cm

folded size(LxWxH): 46x50x13cm

net weight: 4kg

Bearing: 159kg

Material:aluminum alloy, oxford cloth

Packing: 1pcs/carton

Carton size: 52x51x18cm

Gross weight: 5kg



FAFS06

unfolded size(LxWxH): 215x55x50x15cm

folded size(LxWxH): 108x17x9cm

net weight: 6kg

Bearing: 159kg

Material:aluminum alloy, oxford cloth

Packing: 2pcs/carton

Carton size: 110x20x22cm

Gross weight: 13kg

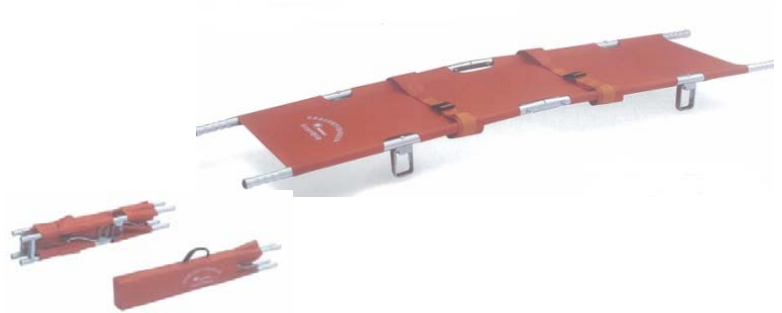

FAFS07

Max unfolded size(LxWxH): 203x42x50x7cm

Min unfolded size(LxWxH): 167x42x7cm

net weight: 9kg

Bearing: 159kg

Material: aluminum alloy

Packing: 1pc/carton

Carton size: 170x41x7cm

Gross weight: 10kg

Usage:

Transfer fractured and serious patients

Can be separated into 2 part widthwise

Can put /release the patient into/off the stretcher without moving

Length Adjustable.

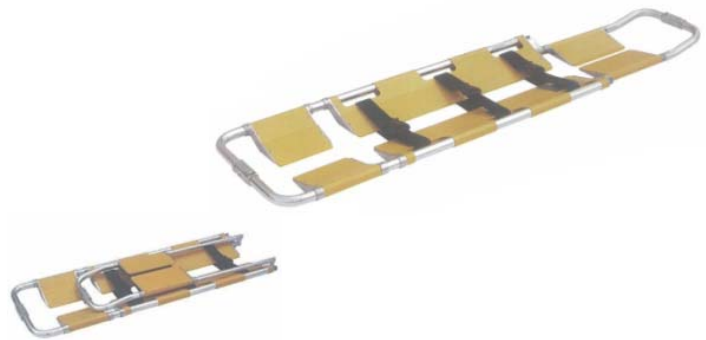

FAFS08

Size(LxWxH): 184x45x5cm

Net weight: 6.5kg

Bearing: 159kg

Material: PE



Oxygen Mask

FAOM01

Oxygen mask

Material: PVC

Specs: L, M, S

Package: 100pcs/carton

Weight: 7.5kg/carton



FAOM02

Oxygen mask with bag

Material: PVC

Specs: L, M

Package: 100pcs/carton

Weight: 7.5kg/carton



FAOM03

Breath machine

Material: PVC/silica gel

Package: 12pcs/carton

Weight: 11kg/carton



FAOM04

Nebulizer Mask

Material: PVC

Specs: S, L, M

Package: 100pcs/carton

Weight: 8kg/carton



FAOM05

Disposable oxygen tube

Material: PVC

Specs: 200cm

Package: 300pcs/carton

Weight: 10kg/carton



FAOM06

Connection tube

Material: PVC

Specs: 200cm

Package: 300pcs/carton

Weight: 10kg/carton



FAOM07

Anesthesia Mask

Material: PVC

Specs: L, M, S

Package: 100pcs/carton

Weight: 7.1kg/carton



Surgical Gown

PT01

Soft and light

Water/oil/alcohol/blood proof.

Anti-static

Avoid cross infection

Material: wood pulp compound spunlace non-woven&SMS/SMMS&Spunlace

30gsm, 40gsm, 60gsm, 70gsm

Size S, M, L, XL, XXL



Woodpulp Spunlace Non-woven Material



Anti-water



SMS, or, SMMS

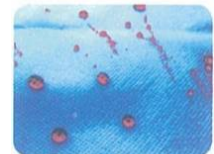

Anti-blood



Spunlace

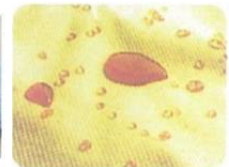

Anti-oil

Surgical Drape

PT02

Good air breath ability

Water/oil/alcohol/blood proof.

Anti-static

Avoid cross infection

Material: SMS & wood pulp compound spunlace non-woven & paper &Poly

Size: 40x40, 60x60, 10801#, 10802#, 10803#, 120x140, 76x150

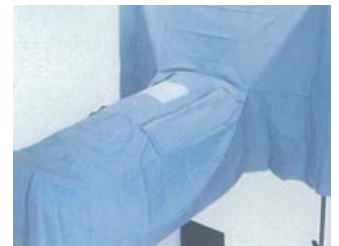

Protective

PT03

Soft and light weight

Comfortable cuts provides free movement

BFE more than 95%

Protective gown

Size: 170cm/175cm/180cm/185cm

Lab coat

Size: S, M, L

Visitor gown

Size: S, M, L



Sleeves

PT04

Waterproof, penetration resistant

Comfortable solid and durable

Material:

Non-woven sleeves 30gsm or 40gsm

Poly sleeves 0.02mm or 0.025mm

Size(cmxcn): 40x18, 45x22, 40x20, 42x22

\



Bed sheet

PT05

Water proof

Penetration resistant

Fits the mattress, soft and durable

Material: non-woven bed sheet

25gsm, 30gsm, 40gsm

Size(cmxcn): 80x150, 90x180, 150x210, 180x240



Pillowcase

PT06

Water proof

Penetration resistant

Soft and durable

Material:

25gsm, 30gsm, 40gsm

Size(cm \times cm): 45 \times 60, 45 \times 70, 75 \times 75



Apron

PT07

Water proof

Penetration resistant

Soft and durable

Material: non-woven 25gsm, 30gsm, 40gsm

Poly aprons 0.03mm

Size(cm \times cm): 70 \times 50, 110 \times 95, 71 \times 115, 80 \times 130, 80 \times 164

Gloves

PT08

Latex examination gloves(w/wo powder)

Elongation at break

Before aging Min 650%

After aging min 500%

Tensile strength

Before aging Min 18Mpa

After aging Min 14Mpa

Length Min 230mm

Width: Extra small \leq 80mm, small 80 \pm 5mm, Medium 95 \pm 5mm, large 100 \pm 5mm, Extra large \geq 110mm

Thickness single wall

Palm 0.08mm min



PT09

Latex surgeon gloves(w/wo powder)

Elongation at break

Before aging Min 750%

After aging min 560%

Tensile strength

Before aging Min 24Mpa

After aging Min 18Mpa

Length Min 280mm

Width: 6 1/2" 83 \pm 3mm, 7" 89 \pm 3mm, 7 1/2" 95 \pm 3mm, 8" 102 \pm 3mm, 8 1/2"

108 \pm 3mm, Thickness single wall

Palm 0.10mm min



PT10

PVC gloves(w/wo powder)

Technical Standard

Elongation \geq 350%Tensile Stengh \geq 10MPa

latex-free

Pin Hole AQL 1.5 (1000ml water-leak test)

Ambidextous-fits either hand

Pre-powdered and powder-free available

Available in many colors

Beaded cuff

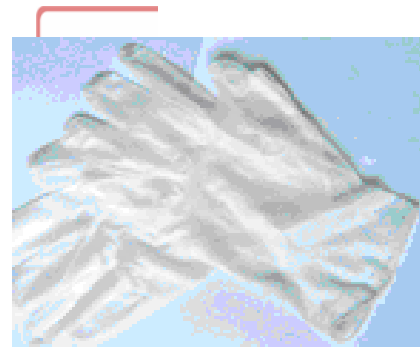

Size	Length	Net Weight	Palm Width	Thickness		
				Fingertip	Palm	Cuff
S	245 \pm 10	5 \pm 0.5	80 \pm 5	0.10 \pm 0.03	0.10 \pm 0.03	0.09 \pm 0.03
M	245 \pm 10	6 \pm 0.5	95 \pm 5	0.10 \pm 0.03	0.10 \pm 0.03	0.09 \pm 0.03
L	245 \pm 10	7 \pm 0.5	105 \pm 5	0.10 \pm 0.03	0.10 \pm 0.03	0.09 \pm 0.03
XL	245 \pm 10	8 \pm 0.5	115 \pm 5	0.10 \pm 0.03	0.10 \pm 0.03	0.09 \pm 0.03

Mask

PT11

Mask Ultrasonic

3 plies tie type (w/wo sterile)

PP+anti-dust clothing

20+20+30

Total 70gsm

**PT12**

2 plies tie type (w/wo sterile)

PP

20+30

**PT13**

Mask Ultrasonic

3 plies ear loop (w/wo sterile)

PP+aut-dust clothing

20+20+40

**PT14**

2 plies ear loop (w/wo sterile)

PP

20+40

PT15

Face mask with eye shield
3 plies tie type
PP+Anti-dust clothing+PP+PC
20+20+40



PT16

Active carbon mask
4 plies ear loop
PP
20+35+20+30

Shoes

PT17

Shoes cover
16cmx38cm PP40g
16cmx36cm CPE2.5g



PT18

Boots cover
45cmx37cm PP40g



Cap

PT19

Cap
Trip type
Double elastic for nurse
PP12g/14g



PT20

Astronaut cap
30cmx12.4cm
PP40g



PT21

Doctor cap
53cm
PP30g



PT22

Nurse cap

53cm

PP30g



Oxygen concentrator

OOC01

Oxygen concentrator

Separate oxygen and nitrogen in the air by zeolite molecular sieve as a shift for medical usage

Oxygen density: $\geq 90\%$

Oxygen flux: 1~5L/min

Output pressure: 0.04~0.05Mpa

Overrunning pressure alarm

Noise: $\leq 55\text{dB(A)}$

Power supply: AC220 \pm 22V, 50 \pm 1HZ

Input power: $\leq 600\text{VA}$



OOC02

Oxygen concentrator(with nebulizing installation)

Separate oxygen and nitrogen in the air by zeolite molecular sieve as a shift for medical usage

Oxygen density: $\geq 90\%$

Oxygen flux: 1~5L/min

Output pressure: 0.04~0.05Mpa

Overrunning pressure alarm

Noise: $\leq 55\text{dB(A)}$

Power supply: AC220 \pm 22V, 50 \pm 1HZ

Input power: $\leq 600\text{VA}$



OOC03

Oxygen concentrator

Separate oxygen and nitrogen in the air by zeolite molecular sieve as a shift for medical usage

Oxygen density: $\geq 90\%$

Oxygen flux: 1~3L/min

Output pressure: 0.04~0.05Mpa

Overrunning pressure alarm

Operation noise: $\leq 49\text{dB(A)}$

Power supply: AC220 \pm 20V, 50 \pm 1HZ



Input power: $\leq 350\text{VA}$

OOC04

Oxygen concentrator(with nebulizing installation)

Separate oxygen and nitrogen in the air by zeolite molecular sieve as a shift for medical usage

Oxygen density: $\geq 90\%$

Oxygen flux: 1~3L/min

Output pressure: 0.04~0.05Mpa

Overrunning pressure alarm

Operation noise: $\leq 49\text{dB(A)}$

Power supply: AC220 \pm 20V, 50 \pm 1HZ

Input power: $\leq 350\text{VA}$



Anti- decubitus products

OAD01

For the ones who lies on bed for long time to prevent bedsores. Or for the ones already with the tissue damage.

It can reduce the pressure to skin.

Anti-decubitus mattress

Whole set: mattress+pump

There are 2 groups of pipes inside the mattress

The pump input air into one group and output from the other group. Shifts every 10 min.

.Material:

working condition: 240V \pm 10% 50HZ \pm 2%

Output power: 65W

Output pressure: 14kPa

Output flux: 7L/min

Bearing: 135kg

Size: 2000mmx900mmx110mm

Weight: 7.5-8kg

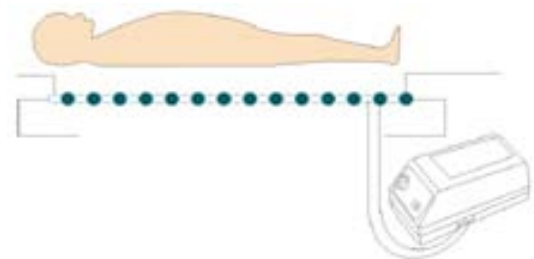

OAD02

Anti-decubitus mattress (air-jet style)

There are tiny holes on the surface of the mattress.

There will be air jet from the mattress inside to decrease the humidity on bed.

It can replace foul air on the skin and control the growth of microbes

Material: rubber nylon sheet or PVC sheet

working condition: 240V \pm 10% 50HZ \pm 2%

Output power: 16W

Output pressure: 20kPa

Output flux: 14L/min

Bearing: 135kg

.Size: 2000mmx900mmx80mm

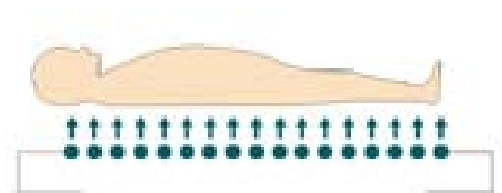

Weight: 6-6.5kg

OAD03

Anti-decubitus seat (round)

Material: flocking

Bearing: 100kg

Size: 390mmx130mmx95mm



OPS01

Portable phlegm suction unit:

Portable phlegm suction unit is a newly designed pump with free lubrication pump.

This unit is used to suck thick liquid, such as phlegm, blood, both for hospital use and home use.

Plastic square crust with the suction bottle inside.

Overflow protection design, preventing phlegm leaking into the machine.

Easy to take way

Voltage: AC220V± 10%, 50Hz±2%

Power: ≤90VA

Max negative pressure value: ≥0.075MPa

Pumping rate: 18L/min

Noise: ≤ 65dB (A)

Reservoir volume: 1000mL, 1piece



OPS02

suction for children

oil-free lubrication pump, with pressure dial. Easy to take.

Voltage: AC220V± 10%, 50Hz±2%

Power: 90VA

Max negative pressure value: ≥0.075MPa

Pumping rate: 15L/min

Noise: ≤ 65dB (A)

Medicine timer box

OMTB01

Reservoir volume: 1000mL, 1piece

Medicine timer box (digital pill reminder timer box, medicine alarm container, pill alarm holder case)

Pill box timer with 8 group alarms setting per day

Two compartments to put the pills in

Large LCD display

Easy to use

bubble bag+white box



size: 10X6.4X1.6CM
Packing: 200PCS/CTN
Package size: 52*37*24cm
G.W./N.W.:13.8/12.8kgs

OMTB02

medicine timer box (digital pill reminder timer box, medicine alarm container, pill alarm holder case)

Large four compartments for pills

Rotatable window for taking out pills

Display current time in 12 hours

8 group alarm clocks

Large & easy-read LCD

Keep reminding if the user don't press any button on the due time

Product Size: 100*64*22mm Battery: one AG10 battery 300pcs/ctn

carton dimension: 56*33.5*37cm



OMTB02

Pills reminder

Large four compartments for pills/medicine.

The pills reminder with six large buttons for easy operation the medicine timer.

24 hours alarm clock remind to take the pills.

can set 4 group alarms per day as a reminder for medicine/pills.

4 group different alarm sound and easy-read LCD.

When the pill alarm time goes off, the different alarm sound and flashing symbol on LCD will remind a user of taking the pills from which compartment.

EL back light: the backlight is good useful at night

Product size:10.6x7.3x1.7cm

Packing: 120PCS/ctn

MEANS: 37.5*34.5*27CM

OMTB03

Pill reminder. medicine timer box (digital pill reminder timer box, medicine alarm container, pill alarm holder case)

99 hours/59 minutes countdown;

Qty/size/ctn: 100pcs/32.5X30.5X20.5cm/ctn

Product size: 9.5x6.0x2.7cm

N.W/G.W: 5.2kg/ctn



OMTB04

medicine timer box (digital pill reminder timer box, medicine alarm container, pill alarm holder case)

Flying plate-look

2. Pill Box Timer

3. The range of timing: Countdown within 24 hours

4. Power: AG13*1(Button)battery

5. Size:83mm*83mm*30mm



Medication Reminder with Pill box

Key Features

24 hours countdown alarm function

2 Pill Compartments

Easy to program

Fits in pocket or purse

Easy to Read display

Operation instruction:

Key A is hour,

Key B is minute,

Key C is Start/pause.

At first, press A and B to set the time you want.

And press key C to begin to countdown (the digits on the LCD flash). If you press C for 2 seconds, the timer will pause (the digits on the LCD do not flash at this moment). If you press key C again, the timer will continue to

countdown the remained time.

When the set time is up, the timer will give out the alarm of beep-beep to remind the user. When the alarm is over, pressing key C will cause the timer to restart timing per the last setting.

Press Key A and B at the same time, the last setting is cancelled. The time can be reset.

If you can not set hours or minutes, please press key A and B at the same time to restart setting.

UNIT SIZE: 83*83*30MM

UNIT N.W.: 71G

MEAS: 47.5*32*46CM

Q'TY/CTN: 180PCS

G./N.W : 13.8/12.8KGS

OMTB05

medicine timer box (digital pill reminder timer box, medicine alarm container, pill alarm holder case)

Medication Reminder with Pill box

Key Features

24 hours countdown alarm function

2 Pill Compartments

Easy to program

Fits in pocket or purse

Easy to Read display

operation instruction:

Key A is hour,

Key B is minute,

Key C is Start/pause.

At first, press A and B to set the time you want.

And press key C to begin to countdown (the digits on the LCD flash). If you press C for 2 seconds, the timer will pause (the digits on the LCD do not flash at this moment). If you press key C again, the timer will continue to countdown the remained time.

When the set time is up, the timer will give out the alarm of beep-beep to remind the user. When the alarm is over, pressing key C will cause the timer



to restart timing per the last setting.

Press Key A and B at the same time, the last setting is cancelled. The time can be reset.

If you can not set hours or minutes, please press key A and B at the same time to restart setting.

Size:85*51*20mm

N.W.:50g

Package size:47.5*32*46cm

Qty: :330pcs/carton

G./N.W:16.8/16kgs

OMTB06

medicine timer box (digital pill reminder timer box, medicine alarm container, pill alarm holder case)

Medication Reminder with Pill box Key Features

1. Capsule-look
2. Pill Box Timer
3. The range of timing: Countdown within 24 hours
4. Power: AG13*1(Button)battery
5. Size: 86mm*31mm*31mm

operation instruction:

Key A is hour,

Key B is minute,

Key C is Start/pause.

At first,press A and B to set the time you want.

And press key C to begin to countdown (the digits on the LCD flash). If you press C for 2 second, the timer will pause (the digits on the LCD do not flash at this moment). If you press key C again, the timer will continue to countdown the remained time.

When the set time is up, the timer will give out the alarm of beep-beep to remind the user. When the alarm is over, pressing key C will cause the timer to restart timing per the last setting.

Press Key A and B at the same time, the last setting is cancelled. The time can be reset.

If you can not set hours or minutes, please press key A and B at the same time to restart setting.

Size: 86*31*31MM

N.W.: 41G

Package size: 47.5*32*46CM

Qty: 280PCS/carton

G./N.W : 12.5/11.5KGS

Toilet seat raiser

Toilet Seat Raiser is an elevated toilet seat designed for use by individuals with balance, mobility, or lower extremity disabilities

OTSR01

Specs: without lock, without armrest

Material: PVC

Size: height 7", width 21", depth 17"

Package: 3pcs/ctn, ctn size: 500*410*425mm



OTSR02

Specs: with locking without armrest

Material: PVC

Size: height 7",width 21",depth 17"

package:3pcs/ctn,ctn size:830*535*400mm



OTSR03

Specs: with locking and with detachable armrest

Material: PVC

Size: height 7",width 21",depth 17"

Package: 3pcs/ctn,ctn size:625*540*480mm



Hearing Aid

OHA01

Behind the ear

Maximum saturation sound pressure level: 112db

Maximum acoustic gain: 38

Working voltage: 1.4v

Bottom battery: A675

Frequency: 300-3500hz



OHA02

Body hearing aid

Maximum saturation sound pressure level: 133db

Maximum acoustic gain: 55db

Working voltage: 1.5v

Bottom battery: AAsize

Frequency: 230-5000hz



OHA03

in the canal (ITC)

Maximum saturation sound pressure level: 110db

Maximum acoustic gain: 24

Working voltage: 1.4v

Bottom battery: A312

Frequency: 200-3300hz



OHA04

in the canal (ITC)

Maximum saturation sound pressure level: 115db

Maximum acoustic gain: 35

Working voltage: 1.4v

Bottom battery: A312

Frequency: 200-3300hz



OHA05

Amplify sounds up to 50 decibels

Weights less than 35 grams

Personal volume control

Fit either ear

Operation Voltage: 1-2V

Current Drain: Max 42-45mA Min 40-43mA

T. H. D@1Khz: 3-6% Max Output THD@1Khz: 30-35% S/N Ratio: 45-50dB

Max Output Power: 10-20mW Frequency Response(-3db) Upper: 1-2KHz

Frequency Response(-3db) Lower: 240-300Hz Total Power Gain 48-50dB

Volume Hum Max 1.5-2mV Min 0.4-0.8mV

Dummy Load 16Ω



OHA06

Amplify sounds up to 40 decibels

Weights less than 10 grams

6 volume levels

Adjust to either ear

Operation Voltage: 1.2-1.6V

Current Drain: 6-8mA

T. H. D@1Khz: 1.2-1.6%

Max Output THD@1Khz: 2.5-3%

S/N Ratio: 50-54dB

Max Output Power: 0.7-0.9mW

Frequency Response(-3db)

Upper: 3-4KHz

Frequency Response(-3db)

Lower: 300-400Hz



Dummy Load: 120Ω

OHA07

Amplify sound up to 40 decibels
Intercept sounds from 15 metres away
Volume control for desired level of amplification
Use it and still go unnoticed
Extremely light weight & small size (2gms w/o battery)
Provide excellent stereo audio quality
MEAS: 37x37x20 CM Operation Voltage 1.4-1.6V
Current Drain Max 6.3-8mA Min 6.3-8mA
T. H. D@1Khz 1.2-2% Max Output THD@1Khz 2-2.5% S/N Ratio 55-58dB
Max Output Power 0.075-0.013mW Frequency Response(-3db)
Upper 3.5-6.5KHz Lower 400-700Hz
Volume Hum: Max 1.0-1.2mV Min 0.2-0.8mV
Dummy Load 120Ω



OHA08

- Fully DSP-based multi-memory amplifier
- 10 bands gain adjust for fine tuning
- 2 channels WDRC compression
- Unique Dynamic Contrast Detection noise reduction technology
- Wideband output compression limiting (MPO)
- Adjustable feedback removal notch

Technical Data	OHA08-01	OHA08-02	OHA08-03
Peak value	137+-3 dB	133+-3dB	133+-3dB
Output at 1600 Hz	127+-3dB	123+-3dB	123+-3dB
Maximum gain	65+-5dB	60+-5dB	60+-5dB
Gain at 1600Hz	58+-5dB	55+-5dB	55+-5dB
Battery current	<=2mA	<=1.5mA	<=1.5mA
Equivalent Input Noise	<=30dB	<=30dB	<=30dB
Total Harmonic Distortion	<=3%	<=3%	<=3%



OHA09-A

- 100% digital
- Concealed programming socket
- Programmable Multi-Microphone Directional Processing
- On/off Switch built into Battery Door
- Programmable Telephone coil
- Multi-memory (1-4) push button with Tone Indicator
- Direct Audio Input (DAI) capability
- Numbered Volume Control
- Push on replaceable earhook
- 13# battery



OHA09-B

- 100%digital
- Concealed programming socket
- Multi-memory(1-4) push button with Tone Indicator
- Direct Audio Input (DAI) capability
- Numbered Volume Control
- 13#battery

OHA10

- Small size hybrid
- powerful output
- low current consumption
- Options:
 - 1) Volume control with switch function
 - 2) H-trimmer
 - 3) L-trimmer
 - 4) Gain trimmer
 - 5) AGCO trimmer
 - 6) Telecoil function

Peak value 115+-3dB 122+-3dB Output at 1600 Hz 112+-3dB 116+-3dB

Maximum gain 45+-5dB 50+-5dB Gain at 1600Hz 35+-5dB 40+-5dB

Battery current <=0.36mA <=1.0mA Equivalent Input Noise <=27dB <=27dB

Total Harmonic Distortion <=3% <=3%

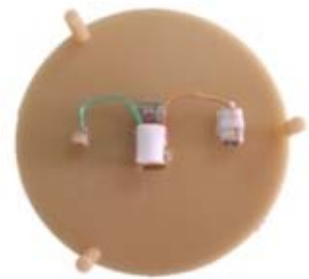

OHA11

- Powerful push-pull output BTE
- Low frequency gain adjustment
- Overall output adjustment
- Telecoil input function
- Audio input function
- 675 # battery

Technical Data	OHA11-01	OHA11-02	OHA11-03
Peak value	137+-3 dB	133+-3dB	133+-3dB
Output at 1600 Hz	127+-3dB	123+-3dB	123+-3dB
Maximum gain	65+-5dB	60+-5dB	60+-5dB
Gain at 1600Hz	58+-5dB	55+-5dB	55+-5dB
Battery current	<=2mA	<=1.5mA	<=1.5mA
Equivalent Input Noise	<=30dB	<=30dB	<=30dB
Total Harmonic Distortion	<=3%	<=3%	<=3%



OHA12

- Fully DSP-based multi-memory amplifier
- 10 bands gain adjust for fine tuning
- 2 channels WDRC compression
- Unique Dynamic Contrast Detection noise reduction technology
- Wideband output compression limiting (MPO)
- Adjustable feedback removal notch
- Digital trimmer and VC capable

Technical Data	OHA12-01	OHA12-02	OHA12-03
Peak value	113+-3dB	120+-3dB	125+-3dB
Output at 1600 Hz	108+-3dB	115+-3dB	119+-3dB
Maximum gain	40+-5 dB	50+-5 dB	57+-5dB
Gain at 1600Hz	35+-5 dB	40+-5 dB	50+-5dB
Battery current	<=1.0mA	<=1.0mA	<=1.5 mA
Equivalent Input Noise<=30dB		<=30dB	<=30dB
Total Harmonic Distortion<=3%		<=3%	<=3%



Cervical Vertebra Traction Device

OCVT01

- Traction power range: 0-60kPa
- Min5-10kPa
- Max 40-60kPa
- Middling: 10-40kPa
- Traction range: 1-15cm
- Size: 200x200x170mm
- Weight: 10.5-11.5kg
- Material:



OCVT02

- Traction power range: 0-30kPa
- Min5-10kPa
- Max 20-30kPa
- Middling: 10-20kPa
- Traction range: 1-20cm
- Size: 240x275x180mm
- Weight: 8.5-7.5kg
- Material:



OCVT03

Traction power range: 0-20kPa

Min5-10kPa

Max 15-20kPa

Middling: 10-15kPa

Traction range: 1-18cm

Size: 235x260x160mm

Weight: 8.5-7.5kg

Material:



Massager

OM01

1. The appearance is luxurious, fashionable and the streamline long handle design, has get the country patent.
2. The streamline is made from eraser material, non-silping and shocking, easy to take and operate.
3. Three work situation, non-step speed adjustment, choice the function and speed freely.
4. Intelligent time controls combined with traditional heat therapy perfectly (3 minutes reach to 48°C), can adjust the eligible temperature, massage together with heat therapy, one massage two enjoys.
5. Attaches two sets changeable massage heads, different period, different effect



Size cm	45×15×14.5
Meas cm	71.5×50.5×51
Package	12PCS
G.W/CTN	30kg

OM02

Characteristics and functions:

1. The streamline long handle design, it is very easy to take and operate
2. Two ball shape massage heads give you more comfortable massage experience
3. 3 kinds of the changeable heads you can chose from
4. Eases the fatigue caused by fierce sports and relaxes the muscle
5. Eases the pains caused by unsmooth circulation of breath and blood perennially
6. Eases the convulsion in the shoulder caused by stiff neck when sleeping
7. Eases the pains caused by fatigue or rheumatism
8. Burns fat and loses weight



Size)cm	39.8×14.8×13.2
Meas)cm	61×46×44.5
Package	12PCS
G.W/CTN	18kg

OM03

Product introduction:

1. The fashionable appearance and the streamline handle shape design are popular with the customers
2. Through the improved massage double hump heads can massage more large area and strengthen massage effect
3. The more humanize design of the thin film switch fasten your operation. It adds the automatic program button, makes the massage more comfortable. four kinds of speed and five massage models can be chosen at will
4. You can enjoy the vibrate massage, far infrared ray and magnetic therapy synchronous



Size	38.3×9.5×11.5
Meas	69×60×46
Package	25PCS
G.W/CTN	34kg

OM04

Features:

1. The streamline dolphin shape design, curve handle to prevent slide, easy massage every part of the body
2. You can enjoy the vibrate massage, far infrared and magnetic therapy synchronous
3. You can choose the three massage heads to make the massage more comfortable and useful



Size	38.5 x 10 x 13.2cm
Meas	69 x 44 x 57cm
Package	25PCS
G.W/CTN	34kg

Condom

Latex Condom is made from latex and it is a main man contraceptive method . We could supply and export various kinds of condom , which could be described and divided by quality standard, width,figure style, color, lubricant, flavor, foil , packing, etc. .

ITEM	ISO4074:2002	EN600:1996	WHO:1998
Length	≥160mm AQL2.5	≥170mm AQL2.5	≥180mm QAL1.0
Pinhole	AQL0.25	AQL 0.25	AQL0.25
Airbirst			
1 volumn	≥16dm AQL1.0	≥18dm AQL1. 0	≥18dm AQL 1.0
2 Pressure	≥1.0kPa	≥1.0kPa	≥1. 0 kPA
Tensile			
1Force N	≥35N AQL2.5	≥39N AQL 1.0	
2 Elongation%	650%AQL2.5	≥700% AQL1.0	
3 Breaking Str Mpa	≥17MPa AQL2.5	≥13MPa AQL1.0	

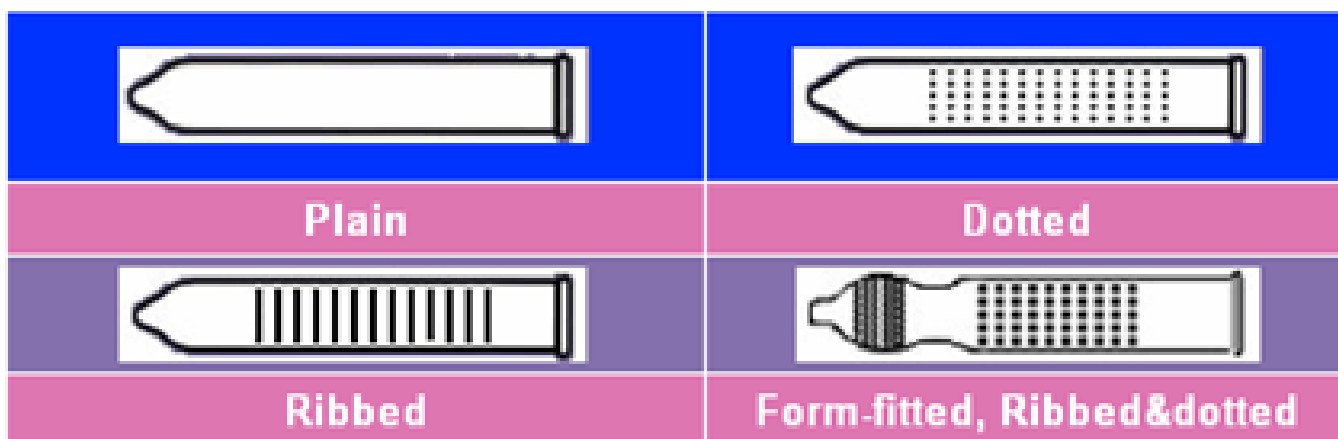

Width: 49MM/52MM/55MM

Length: ≥160mm/170mm/180mm

Color: neutral/pink/red/yellow/blue/green etc.

Flavor: banana/apple/strawberry etc

Lutricant: silicon oil/non-oxynol 9/No Lubricant